

NEMTEK
www.nemtek.com



AGRI
AGRI Solar

Electric Fence
Energizers

Instruction Manual



Introduction & Company profile _____	3
Guarantee _____	4
Nemtek Group outlets _____	5
Foreword _____	6
Symbol key _____	7
Energizer details & mounting _____	8
Energizer features _____	9
Product specification _____	10
Operating without a key-chain remote _____	11
Using the Nemtek key-chain remote _____	12
Operating with a key-chain remote _____	13 - 15
Installation notes _____	16
Appendices _____	17 - 20
Document revision history _____	21

INTRODUCTION

Thank you for choosing our product! NEMTEK Electric Fence Energizers are designed and manufactured to provide many years of reliable use, if installed and maintained correctly. The guidelines provided in this manual will assist you with the basic operation and maintenance of your energizer.

Currently this energizer is designed and manufactured in South Africa for the South African and international markets. More information on our products and general information are available on our web site at: <http://www.nemtek.com>.

COMPANY PROFILE

The NEMTEK Group of Companies manufacture and distribute intelligent electronic agricultural fencing systems, security and perimeter control systems and have been involved in the security industry since 1990.

We have our own research and development team, designing and manufacturing a full range of globally competitive electric fence energizers and related products.

NEMTEK is continually updating its products according to South African and international standards in order to ensure the highest quality products and continuous customer satisfaction.

Electric fencing can be lethal. Avoid head contact with the fence. When installing please take careful note of the options available for current limiting resistors, the programmable output energy levels as well as the low-voltage operation of the energizer.

GUARANTEE

This energizer, manufactured by IO Tech Manufacturing (Pty) Ltd, is guaranteed for a period of two years from date of sale against defects due to faulty workmanship or materials.

IO Tech Manufacturing (Pty) Ltd will, at its discretion, either repair or replace a product that proves to be defective.

IO Tech Manufacturing (Pty) Ltd guarantees that the product, when properly installed and used in line with the specification as determined by IO Tech Manufacturing (Pty) Ltd from time to time, will execute its function of generating a suitable potential. IO Tech Manufacturing (Pty) Ltd does not guarantee that the operation of the product will be uninterrupted and totally error free. Faulty units must be returned to one of the Nemtek Group outlets. The buyer shall pay all shipping and other charges for the return of the product to Nemtek or Nemtek Security Warehouse.

LIMITATION OF GUARANTEE

The guarantee does not apply to defects resulting from acts of God, modifications made by the buyer or any third party, misuse, neglect, abuse, accident and mishandling.

EXCLUSIVE REMEDIES

The remedies provided herein are IO Tech Manufacturing (Pty) Ltd's sole liability and the buyer's sole and exclusive remedies for breach of guarantee. IO Tech Manufacturing (Pty) Ltd shall not be liable for any special, incidental, consequential, direct or indirect damages, whether based on contract, tort, or any other legal theory. The foregoing guarantee is in lieu of any and all other guarantees, whether expressed, implied, or statutory, including but not limited to warranties of merchantability and suitability for a particular purpose.

HEAD OFFICE

Tel: +27 (0)11 462 8283
Fax: +27 (0)11 462 7132

Northriding Commercial Park
Stand 251, Aintree Street, Northriding
Randburg, South Africa

EXPORTS

Tel: +27 (0)11 462 8283
Fax: +27 (0)11 462 7132

exports@nemtek.com

EDENVALE

Tel: +27 (0)11 453 1970
Fax: +27 (0)11 453 1858

Unit 4, Meadowdale Park
Cnr. Dick Kemp & Herman Roads
Meadowdale, Edenvale, South Africa

CAPE TOWN

Tel: +27 (0)21 386-3742
Fax: +27 (0)21 386-5573

27B Concord Crescent, Airport City
Cape Town, South Africa

NELSPRUIT

Tel: +27 (0)13 752-2187
Fax: +27 (0)13 752-2188

Waterval Ave, Riverside Industrial
Nelspruit, South Africa

KWAZULU-NATAL

Tel: +27 (0)31 701-2125
Fax: +27 (0)31 701-2125

Unit 30, Devon Park, 11 Devon Road
Pinetown, South Africa

AUSTRALIA

Tel: (08) 9303 9855
Email: nemtek@bigpond.net.au

Unit 5, 19 Innovation Circuit,
Wangara, 6065, Perth, WA, Australia

Website: www.nemtek.com

E-mail: nemtek@nemtek.com

Manufactured in South Africa

The Agri and Agri Solar range of energizers should ideally be operated together with a Nemtek key-chain remote to gain access to the many energizer settings and information. The energizer will however operate as a conventional energizer without the Nemtek remote.

When the energizer settings are changed, using the Nemtek key-chain remote, the new settings will be retained even when the energizer is disconnected from a power source for an extended period of time.

This energizer includes a theft deterrent feature. The energizer can be locked to a user chosen PIN. This PIN is entered and stored within a Nemtek key-chain remote. When this function is enabled, the energizer is prevented from operating until after a Nemtek remote, containing the correct PIN, is presented to the energizer. Each time power is removed and restored to the energizer, the Nemtek remote will need to be presented, to activate the energizer.

The Agri and Agri Solar range of energizers incorporate our advanced and patented fence voltage control system, referred to as Adaptive Power Technology or APT. What this means is the fence energy is maintained at a higher level than would normally be achievable using a conventional energizer on the same fence, when factors such as poor or damaged insulators, wet insulators after a rain storm, or salt build up on insulators (at the coast) prevent the fence from supporting a high voltage. A conventional energizer will push all available energy through any significant arcing present on the fence, reducing the fences effectiveness. This energizer, with APT control active, will detect any significant arcing and attempt to operate the fence at a voltage just below that at which the arcing occurs, thus maintaining higher energy levels on the fence and improving the effectiveness of the fence. Nemtek is the inventor and patent holder of this innovative technology.

Symbols on the energizer body



Represents the communication target



Represents fence earth connection, terminal



Represents fence live connection, terminal



Represents power from solar panel



Represents power from battery/supply

Symbols on the Nemtek key-chain remote body



Represents the communication target



Represents right button



Represents left button



Represents centre button

Symbols in the remote menu



Represents day operating mode



Represents night operating mode

AGRI AGRI Solar

Energizer details & mounting

BACK VIEW

Mounting Bracket
(various options - see below)

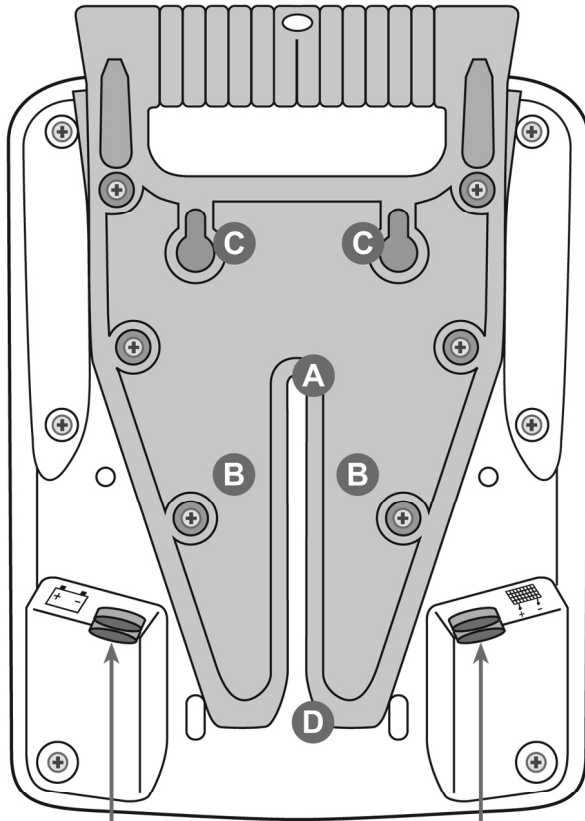

Battery Connections

Solar Connections

FRONT VIEW

'SOLAR' Solar power status (Solar units only)
'BATTERY' Battery Status Indication (SUPPLY on mains unit)
'ENERGIZER' Pulse Rate & Warning Light
Day/Night Sensor

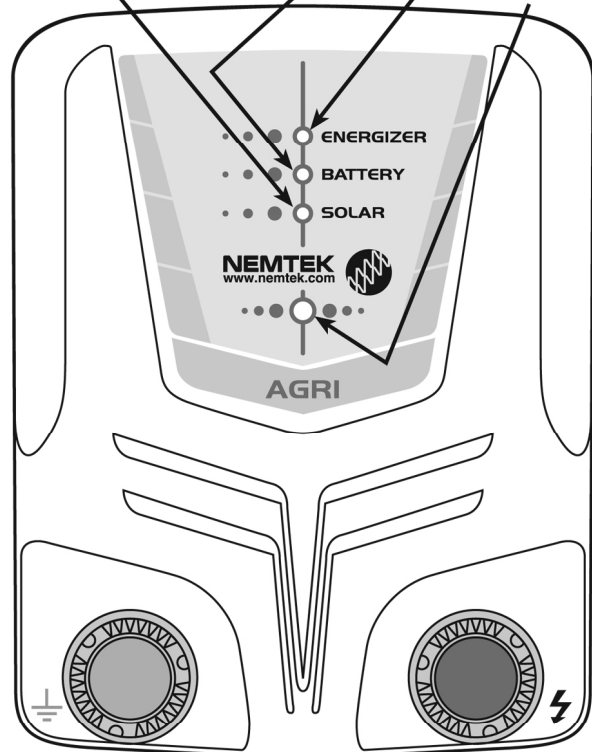

Fence Ground

Fence High Voltage

MOUNTING BRACKET OPTIONS

Note: Slot on top of bracket is for solar panel mounting

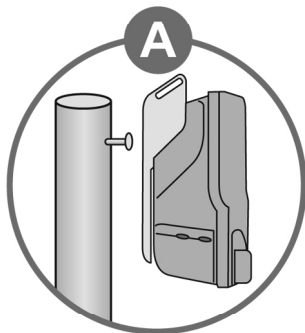

Hanging on a nail hammered into a wooden post (using the slot in the bracket)

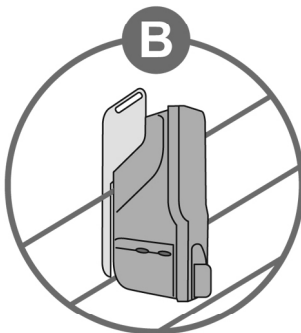

Hanging on a wire fence using the 'bunny teeth' sections of the mounting bracket

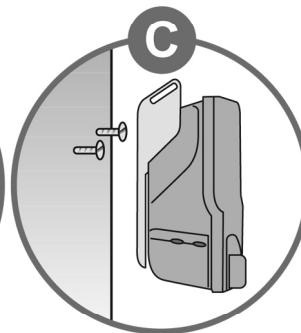

Wall mounted with 2x screws using the screw-mount slots on the mounting bracket

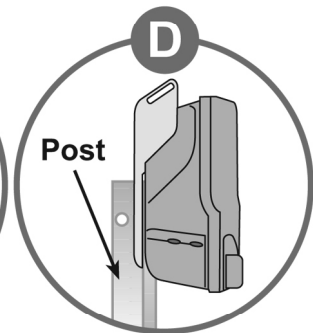

Mounted on a metal fence post using the specially designed slot in the bracket

- Robust weather resistant housing
- Power status indication (BATTERY for solar and SUPPLY for mains units)
green = charged, red = low, yellow = in-between
- Pulse rate and warning light (ENERGIZER on the unit)
green = below warning threshold, red = above warning threshold
- Solar regulator status (SOLAR on the solar unit)
green = battery charging, unlit LED = battery discharging,
red = battery not connected
- Day/night sensor
- Internal warning buzzer for reversed polarity or beeps when using Nemtek Tag
- Internal solar regulator on the Agri Solar units
- Nemtek Advanced Power Technology (APT)
- Accurate control of fence voltage over a wide range of fence conditions

Optional Key-chain remote required for the following features

- Adjustable fence voltage
- Adjustable pulse rate
- Independent day/night setting of fence voltage and pulse rate
- Fence voltage control switchable between conventional and APT methods
- Adjustable energizer overload warning threshold
- Accurate battery voltage reporting
- Accurate fence voltage reporting
- Energizer effort reporting
- Nemtek Security Lock energizer theft deterrent
- Lowest recorded fence voltage memory
- Highest recorded energizer effort memory

Optional Nemtek Tag

- Used to toggle the energizer active state (on/off)

Agri Solar

	10 Solar	25 Solar	50 Solar
Power Supply	12V battery	12V battery	12V battery
Power consumption (100% effort)	1.6W	3.1W	6.3W
Output energy into 330ohm	1J	2.3J	4.6J
Stored energy	1.4J	3.1J	6.5J
Maximum fence voltage	8kV	9kV	9kV
Environmental rating	IP65	IP65	IP65
Fence length light vegetation	10km	25km	50km
Fence length dense vegetation	1km	2.5km	5km
Recommended PV panel	10W	20W	40W
(Open circuit voltage (max) = 23V)			
Recommended battery	12Ah	28Ah	50Ah

Agri mains

	30	50
Power Supply	11V to 16V	11V to 16V
Power consumption (100% effort)	4.3W	6.6W
Power supply rating	12V, 1.5A, 18W	12V, 1.5A, 18W
Output energy into 330ohm	3J	4.9J
Stored energy	4.4J	6.9J
Maximum fence voltage	9kV	9kV
Environmental rating	IP65	IP65
Fence length light vegetation	30km	50km
Fence length dense vegetation	3km	5km

Note: All specifications and recommendations based on 1.5 second pulse rate

AGRI AGRI Solar

Operating without a key-chain remote

Operating the energizer without a Nemtek remote is straightforward. Once the energizer is connected to the fence, plug the black (-) battery clip into the energizer and clip the other end of the lead onto the battery negative terminal. Then plug the red (+) battery clip into the energizer and clip the other end of the lead onto the battery positive terminal. Agri Solar units have dedicated solar power connectors. If the factory default settings have not been altered, the energizer will begin operating at 8kV pulsing once per 1.5 seconds. The pulse rate & warning light should flash once with each fence pulse.

If the pulse rate and warning light (ENERGIZER) changes colour from green to red the energizer is working harder than 95% of its design capacity. The higher the fence voltage is set, or the larger the fence, or more foliage touching the fence, the greater the energizer effort required to energize the fence.

The power status indicator (BATTERY for solar and SUPPLY for mains versions) glows green if the battery voltage is greater than 11.6V, glows red when the battery voltage falls below 10.5V and glows yellow when the battery voltage is between 10.5V and 11.6V. The energizer will shutdown when the battery voltage falls below 10V.



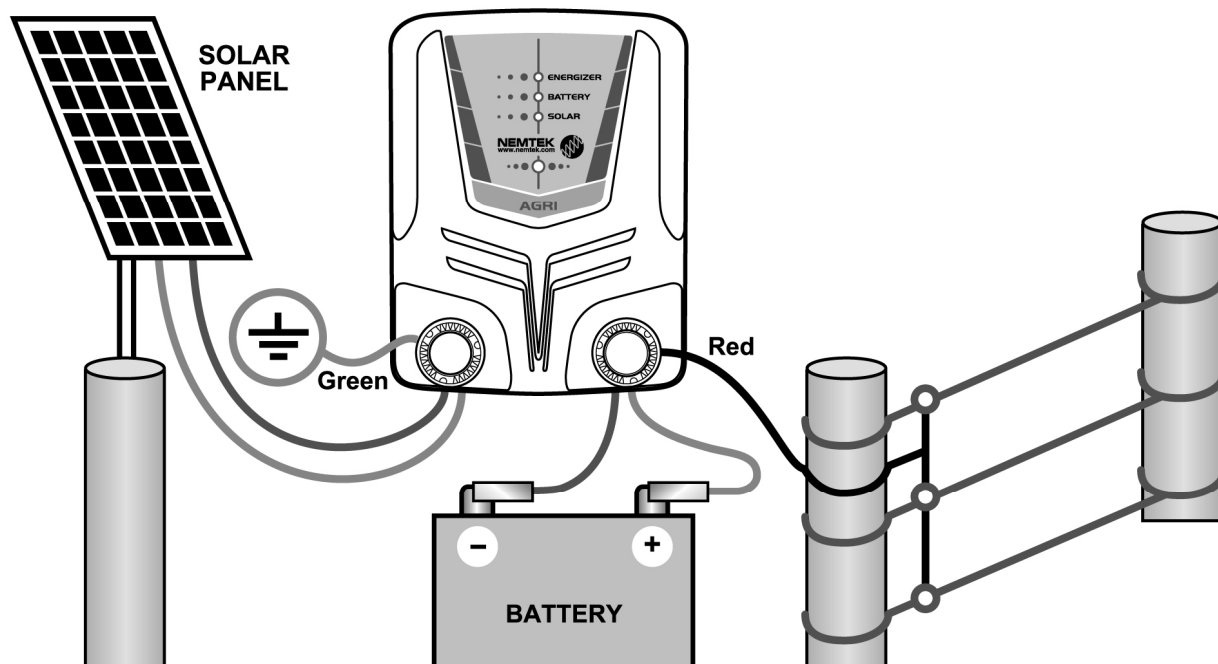

Solar regulator status (SOLAR) is green when the battery is charging, unlit when the battery is discharging and red when the battery is not connected.

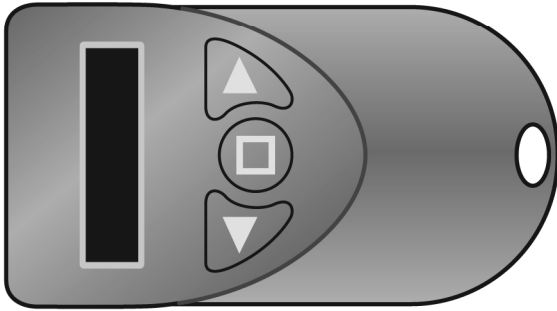

As well as the Nemtek remote, a Nemtek tag is available which is used to toggle the energizer active state (on/off). The Nemtek tag is supplied with the energizer.















The Nemtek key-chain remote functions as either a handy torch, an interface to the Agri range of energizers, or as an activation key to the energizer when the Nemtek Security Lock is active.

The torch can be activated in two ways. By either holding down the  button until the torch activates, or by switching the remote on, navigating through the menu to the item TORCH, and selecting that function by pressing the  button again. With the torch activated, you can increase brightness by pressing the  button. To increase brightness quickly, press and hold the  button. Use the  button to decrease brightness.

To activate the Nemtek key-chain remote menu, press the  button firmly, and release it. Don't press it so long that the torch is activated. To preserve the remote's batteries, the  button is designed such that very short presses or bumps of the button will not activate the remote. Additionally, the remote will automatically switch off after 30s of inactivity.

Use the  and  buttons to navigate back and forth through the remote's internal menu. To select the displayed item, press the  key briefly. Some items, such as PIN, require the  button to be pressed for an extended period, so as to prevent unintentional changes.

The user PIN is used in the security function of the energizer. To set the user PIN, long press of the  button while the item PIN is displayed. Step through the digits by repeatedly pressing and releasing the  button. The flashing cursor beneath the digit to be edited will move one digit to the right with each press and release of the  button. Increase or decrease the value of a digit by pressing the  or  buttons. Once the desired PIN is set by repeating this process for each digit in the PIN, commit the pin to the remote's memory by holding down the  button until you are returned to the NEMTEK display. The PIN is stored in the remote even when the batteries are removed, so the PIN need only be set once.

You need to remember or make a note of this PIN for later referral so that you can re-enter this same PIN into a new remote, should your existing remote be lost or destroyed. If you have locked an energizer using a remote, and no longer have access to that remote, and do not know what PIN was programmed into the remote, then you will have to return with the energizer to Nemtek or an authorized outlet for unlocking.

To turn the remote off, navigate back to the NEMTEK display and press the  button.

AGRI AGRI Solar

Using the Nemtek key-chain remote

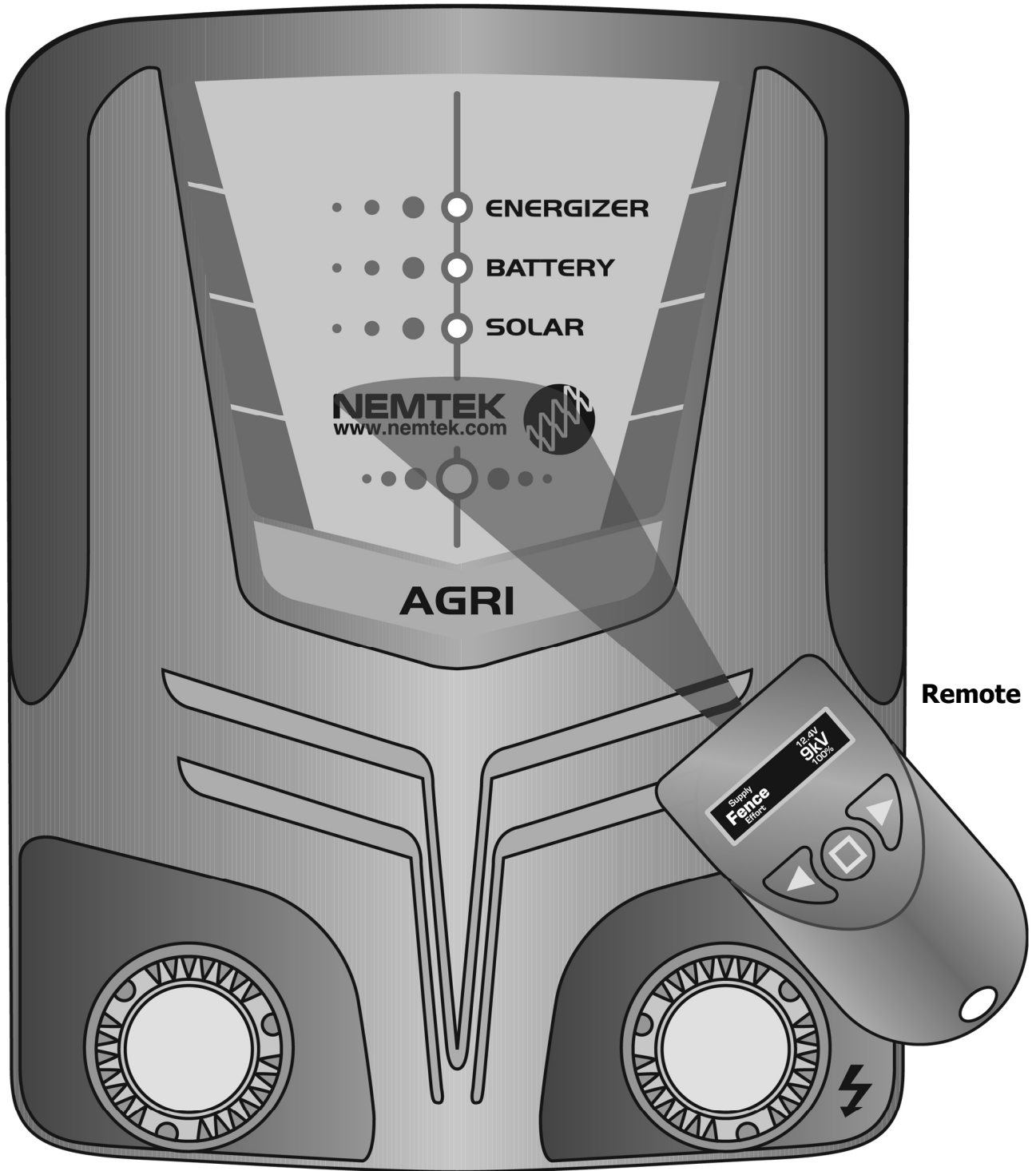

Energizer







Instructions on how to present your remote to your energizer are on page 14.

Operating the energizer with a Nemtek key-chain remote is the same as for operating the energizer without a remote, except that, if the energizer has been locked, then at power on, the Nemtek key-chain remote will have to be presented to the energizer before it begins operating.

To present a remote to the energizer, perform these following steps;

- Turn the Nemtek key-chain remote on as discussed in the previous section.
- Be sure you have activated the menu and not the torch.
- Hold the remote such that the  symbol near the top right of the remote is over the Nemtek  logo on the front of the energizer (see drawing on page 13).
- Keep the remote in place for a second or two, after which you should hear a short beep from the energizer indicating successful completion of a transaction. If instead a long beep is heard, then the energizer has been locked with a different pin to that contained in the remote you are using. If no beep sound is heard, slowly move the remote over the face of the energizer in the vicinity of the Nemtek  logo.
- On hearing the beep, you can move the remote away from the energizer and a new energizer menu will appear on the display of the remote, through which you can start navigating.

The energizer menu:

Menu item	Lower limit	Upper limit	Factory default	Description
Supply information	-	-	-	Battery/mains supply voltage
Fence	-	-	-	Present fence operating voltage information
Effort	-	-	-	Energizer effort or capacity being used, at present, to drive the fence at the set voltage.
 Set	Off / 2 kV	10 kV	8 kV	Fence day light set point voltage
 Rate	1 second	4 second	1.5 second	Fence day light set pulse rate
 Set	Off / 2 kV	10 kV	8 kV	Fence night set point voltage
 Rate	1 second	4 second	1.5 second	Fence night set pulse rate
Warn at	60%	95%	95%	Energizer effort threshold at which the high intensity warning light begins to double flash
Control	-	-	APT	Fence voltage Conventional or Adaptive control method
Locked	-	-	No	Nemtek energizer security lock function enable or disable
V min	-	-	-	Lowest recorded fence voltage (reset after remote presentation)
% max	-	-	-	Highest recorded fence effort (reset after remote presentation)

Navigate through the energizer menu using the ► or ◀ buttons.

To change a setting, press and hold the □ button until a flashing cursor appears beneath the value to be altered*.

Alter the value using the ► or ◀ buttons and then return to navigate further by pressing the □ button briefly.

Once you are satisfied with your new settings, present the remote to the energizer again, to transfer the new settings to the energizer.

A short press of the □ button, while navigating the menu, will switch the remote off.

Additional information on menu items

Energizer effort or capacity used is useful in determining if your fence condition has changed since installation. It can also be used to indicate that the energizer is unable to drive the fence load. To use as a fence condition change indicator, set the WARN AT value above that of the reported EFFORT value. When the loading on the fence increases and the energizer starts to work harder, the high intensity warning light will begin to flash and will be seen from a distance. To use as an energizer maximum capacity reached warning, set the WARN AT value to 95%. When the high intensity warning light begins to double flash, you will know the voltage on the fence is about to, or has already, dropped below the set voltage.

V MIN, is the lowest fence voltage recorded since the energizer was last read using a remote.
% MAX, is the maximum energizer effort or capacity used since the energizer was last read using a remote.

As examples of use for this information, consider the following scenario;

If the fence is being shorted out by faulty insulators during a patch of rain this would be recorded and reported the next time the remote is presented.

If the fence is being deliberately shorted in order to gain access to your animals at night, then this would be recorded as a % MAX value of 100% and a low V MIN value.

As this information is reset each time the remote is presented to the energizer, be sure to remove the remote after the first beep else the recorded values will be lost.

Notes

*Only energizer settings can be altered. Information items such as supply voltage and energizer effort cannot be altered as they are presented as information only.

- Keep the fence separate from the battery wiring.
- Do not try and modify the energizer. Any unauthorized modifications will null and void the warranty and possibly render the unit illegal.
- Use HT (high voltage) wire between the fence and energizer, including the earth wire. Never run these wires in the same conduit or through the same hole as the low voltage wiring.
- Always use ferrules or line clamps to connect two high voltage wires together. Avoid using dissimilar materials for connections, like copper on steel.
- The fence must be earthed properly with three earth electrodes close to the energizer. The distance between the fence earth electrode and any other earth systems shall not be less than 2m for a security fence installation (typically a suburban property installation), and 10m for an agricultural fence installation (typically a rural property installation).
- Refer to the applicable laws concerning the installation of electric fences in your area.

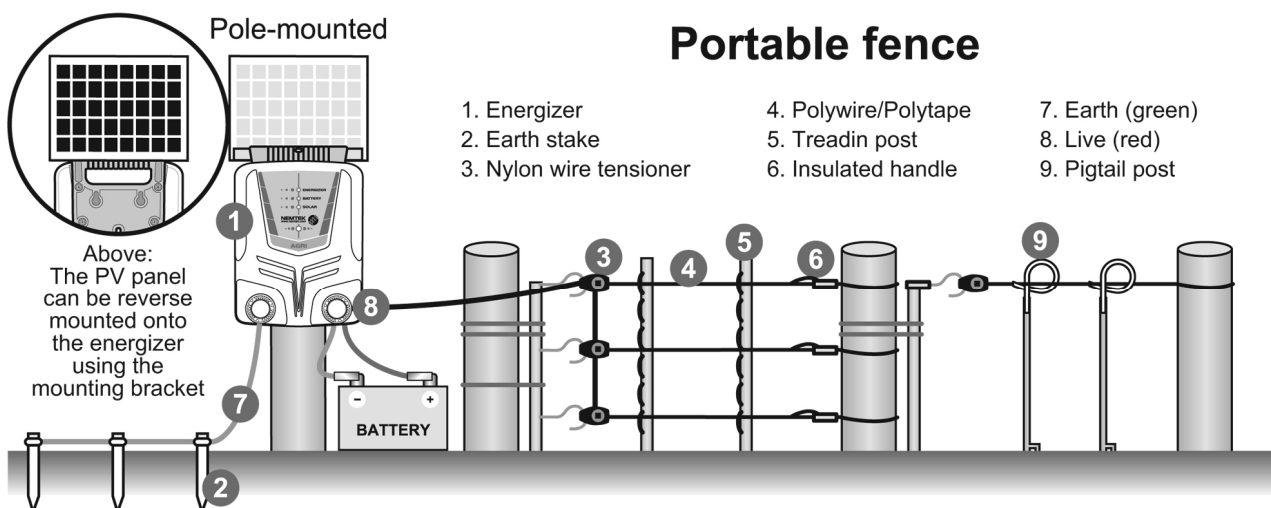
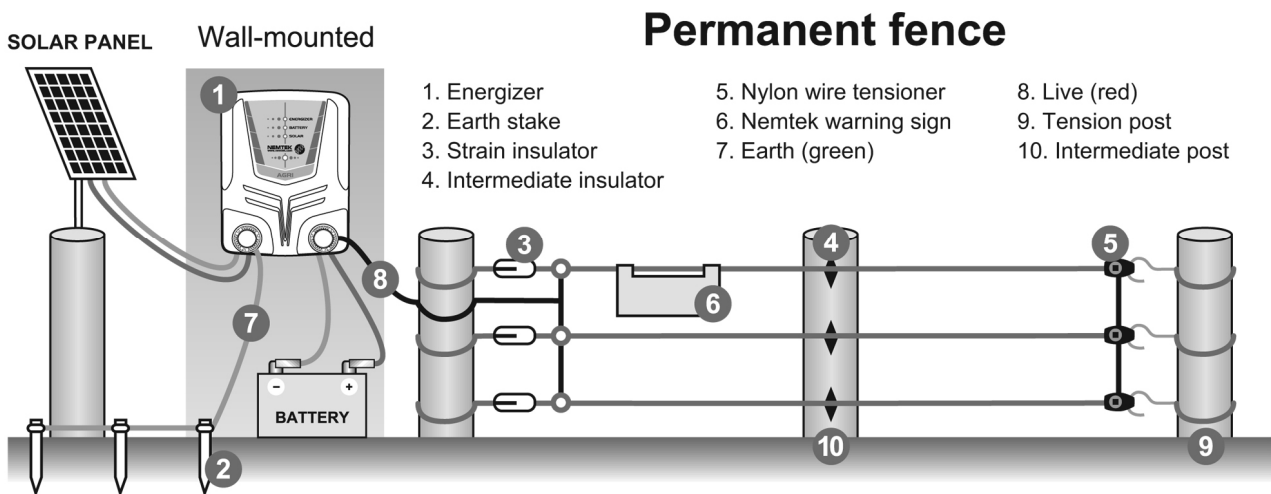

Basic definitions

- **Energizer:**
An appliance intended to periodically deliver voltage impulses to a fence connected to it.
- **Electric Fence:**
A barrier which includes one or more electric conductors, insulated from earth, to which electric pulses are applied by an energizer
- **Connecting Lead:**
An electric conductor, used to connect the energizer to the electric fence or the earth electrode
- **Electric animal fence:**
An electric fence used to contain animals within or exclude animals from a particular area
- **Public Access Area:**
Any area where persons are protected from inadvertent contact with pulsed conductors by a physical barrier
- **Pulsed Conductors:**
Conductors which are subjected to high voltage pulses by the energizer
- **Earth electrode:**
Metal structure that is driven into the ground near an energizer and connected electrically to the fence earth terminal of the energizer, and that is independent of other earthing arrangements.

General requirements for electric fences

Electric fences shall be installed and operated so that they cause no electrical hazard to persons, animals or their surroundings.

Electric fence constructions which are likely to lead to the entanglement of animals or persons shall be avoided.

An electric fence shall not be supplied from two different energizers or from independent fence circuits of the same energizer.

For any two different electric fences, each supplied from a different energizer with independent timing, the distance between the wires of the two electric fences shall be at least 2.5m. If this gap is to be closed, this shall be affected by means of electrically nonconductive material or an isolated metal barrier.

Barbed wire or razor wire shall not be electrified by an energizer.

Electric fences and their ancillary equipment shall be installed, operated and maintained in a manner that minimizes danger to persons, and reduces the risk of persons receiving an electric shock unless they attempt to penetrate the physical barrier, or are in a secure area without authority. Exposed conductive parts of the physical barrier shall be effectively earthed.

A spacing of 2.5m shall be maintained between non insulated electric fence conductors or non insulated connecting leads supplied from different energizers. This spacing may be less where conductors or connecting leads are covered by insulating sleeving, or consist of insulated cables, rated to at least 10kV.

This requirement need not apply where the separately energized conductors are separated by a physical barrier, which does not have any openings greater than 50mm.

A vertical separation of not less than 2m shall be maintained between pulsed conductors fed from different energizers.

Ensure that all ancillary equipment connected to the electric fence circuit provides a degree of isolation between the fence circuit and the supply mains equivalent to that provided by the energizer. Protection from the weather shall be provided to the ancillary equipment unless this equipment is certified by the manufacturer as being suitable for use outdoors, and is of a type with a minimum degree of protection IPx4.

Connecting leads that are run inside buildings shall be effectively insulated from the earthed structural parts of the building. This may be achieved by using insulated high voltage cable.

Connecting leads that are run underground shall be run in a conduit of insulating material or else insulated high voltage cable shall be used. Care shall be taken to avoid damage to the connecting leads due to external factors.

Connecting leads shall not be installed in the same conduit as the mains supply wiring, communication cables or data cables.

Connecting leads and electric fence wires shall not cross above overhead power or communication lines.

Any part of an electric fence which is installed along a public road or pathway shall be identified at frequent intervals by prominently placed warning signs securely fastened to the fence posts or firmly clamped to the fence wires. The size of the warning signs shall be at least 100mm x 200mm. The background colour of both sides of the warning plate shall be yellow. The inscription on the plate shall be in black.

The warning sign shall typically appear as depicted in the figure below. The inscription shall be indelible, inscribed on both sides of the warning plate, and have a height of at least 25mm.



Warning signs shall be placed at;

- each gate
- each access point
- intervals not exceeding 10m
- adjacent to each sign relating to chemical hazards for the information of emergency services.

Gates in electric fences shall be capable of being opened without the person receiving an electric shock.

Mains supply wiring shall not be installed in the same conduit as signaling leads associated with the electric fence installation.

Where an electric fence passes below bare power line conductors, the highest metallic element shall be effectively earthed for a distance of not less than 5m on either side of the crossing point.

Crossings with overhead power lines shall be avoided wherever possible. If such a crossing cannot be avoided, it shall be made underneath the power line and as nearly as possible at right angles to it.

If connecting leads and electric fence wires are installed near an overhead power line, the clearances shall not be less than those shown in the table below.

Power Line Voltage	Clearance
Equal or less than 1kV	3 meter
Greater than 1kV, but equal or less than 33kV	4 meter
Greater than 33kV	8 meter

If connecting leads and electric fence wires are installed near an overhead power line, their height above the ground shall not exceed 3m.

This height applies either side of the orthogonal projection of the outermost conductors of the power line on the ground surface, for a distance of:

- 2m for power lines operating at a nominal voltage not exceeding 1kV
- 15m for power lines operating at a nominal voltage exceeding 1kV

Warning

There are no serviceable parts inside the energizer.

This appliance is not intended for use by persons (including children) with reduced physical, sensory or mental capabilities or lack of experience and knowledge, unless they are supervised or have been given instruction on the correct use of the appliance by a competent and responsible person.

Non-rechargeable batteries must not be connected to this device while the energizer is powered from an alternate power source.

Rechargeable vented batteries must be placed in a well ventilated area during charging.



This symbol indicates that only approved power supplies can be connected to the battery terminals of this energizer in order to power it from the mains supply. See reference numbers on the label. Units will be available from your local distributor. Do not connect the energizer to any other power sources at the same time that it is connected to the mains supply.

Rev 1.0, 18 December 2014

First release

Rev 1.1, 31 May 2016

Warning on power supplies updated